

ISOLATO B - U.E. 1

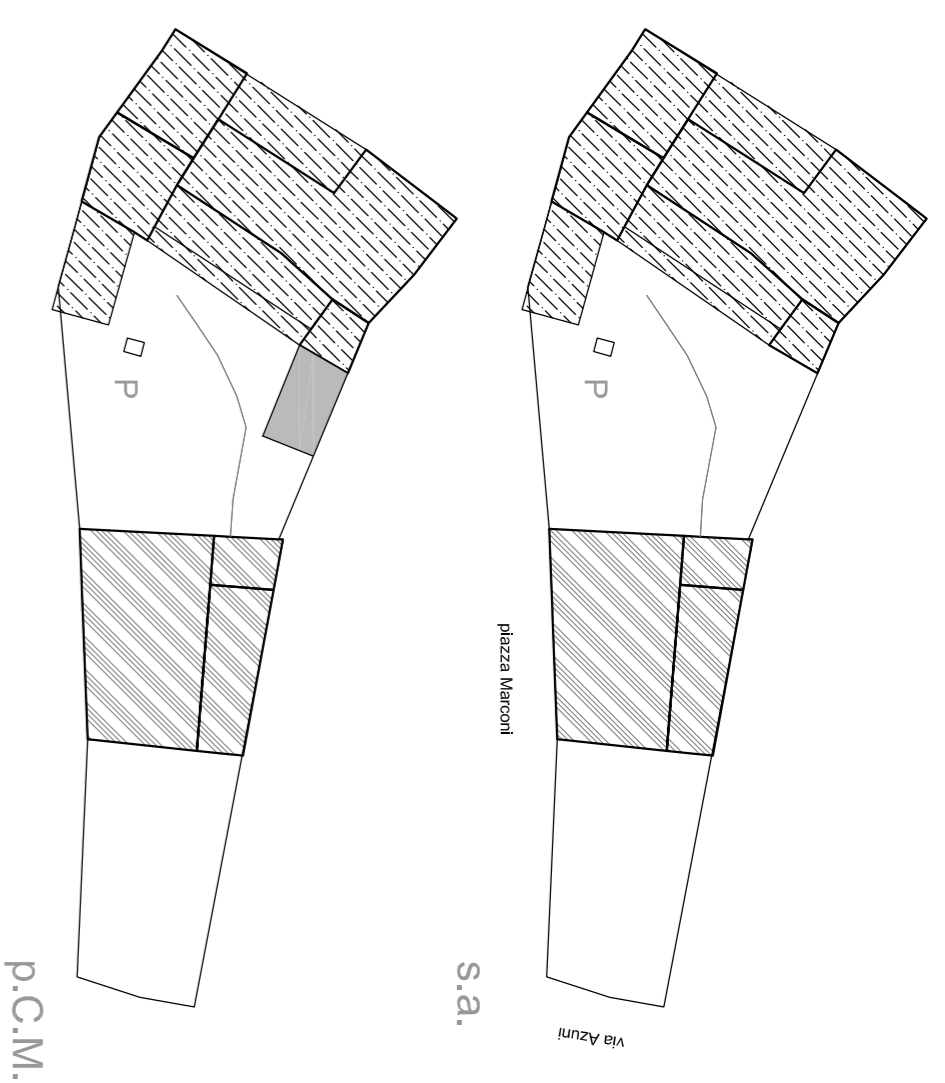

ISOLATO C - U.E. 1

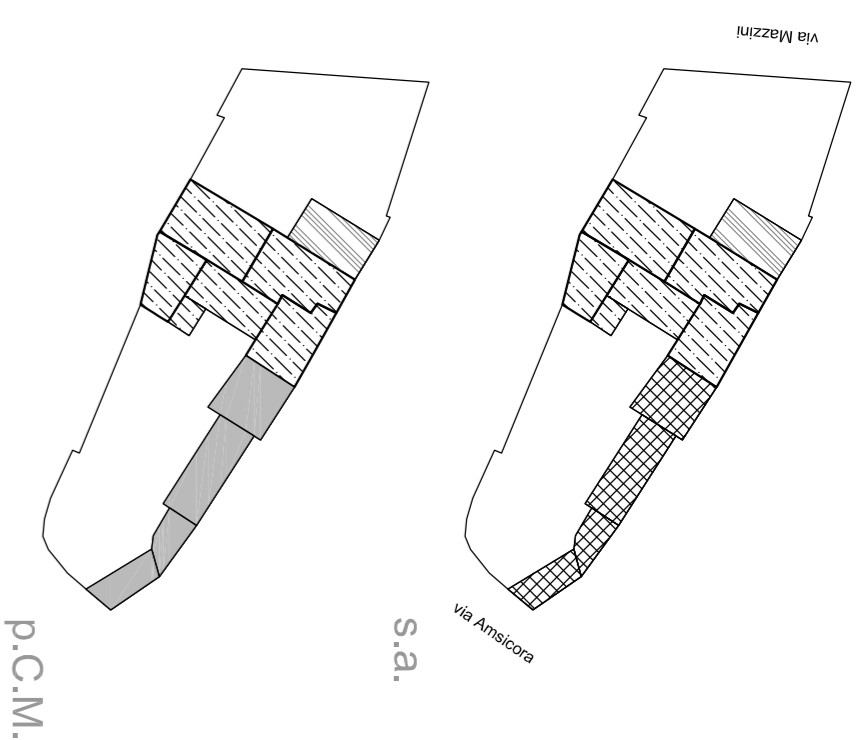

ISOLATO C - U.E. 2

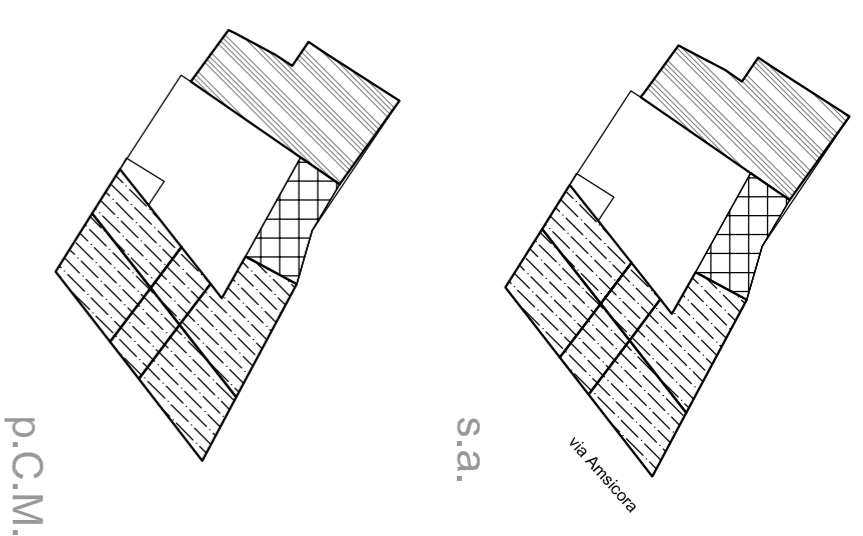

ISOLATO C - U.E. 3

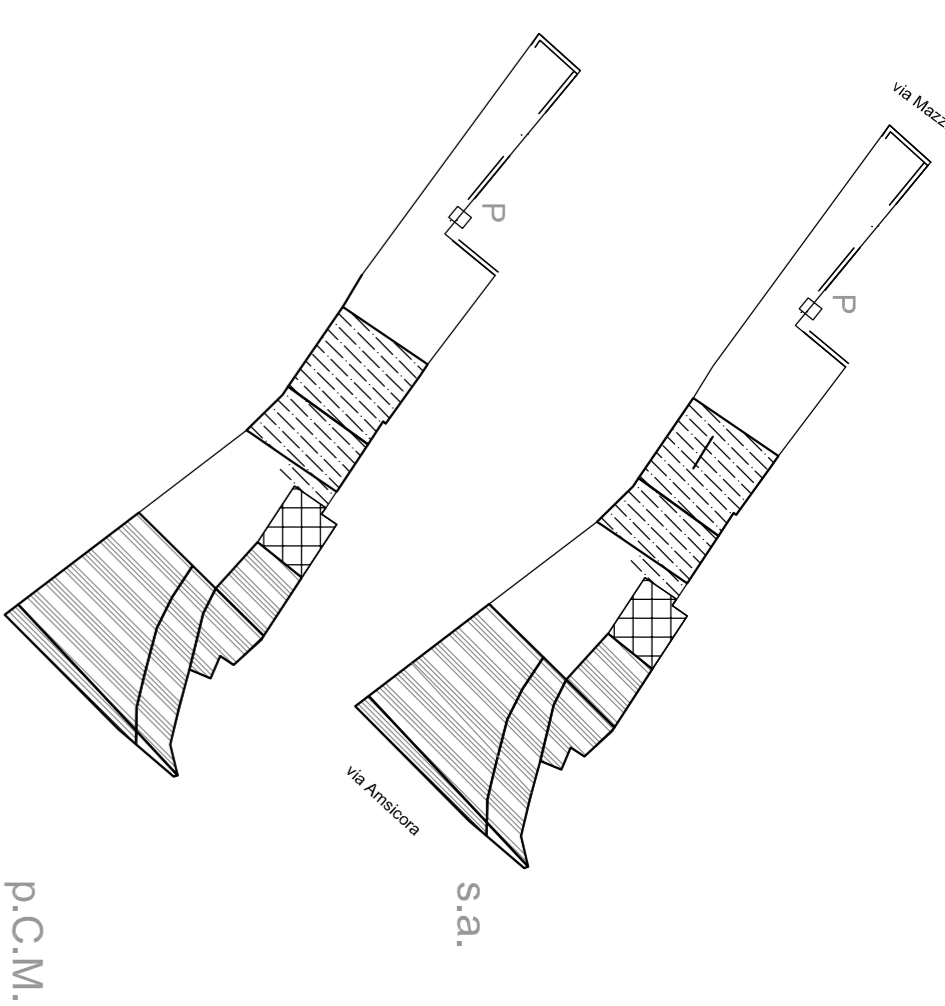

ISOLATO D - U.E. 1

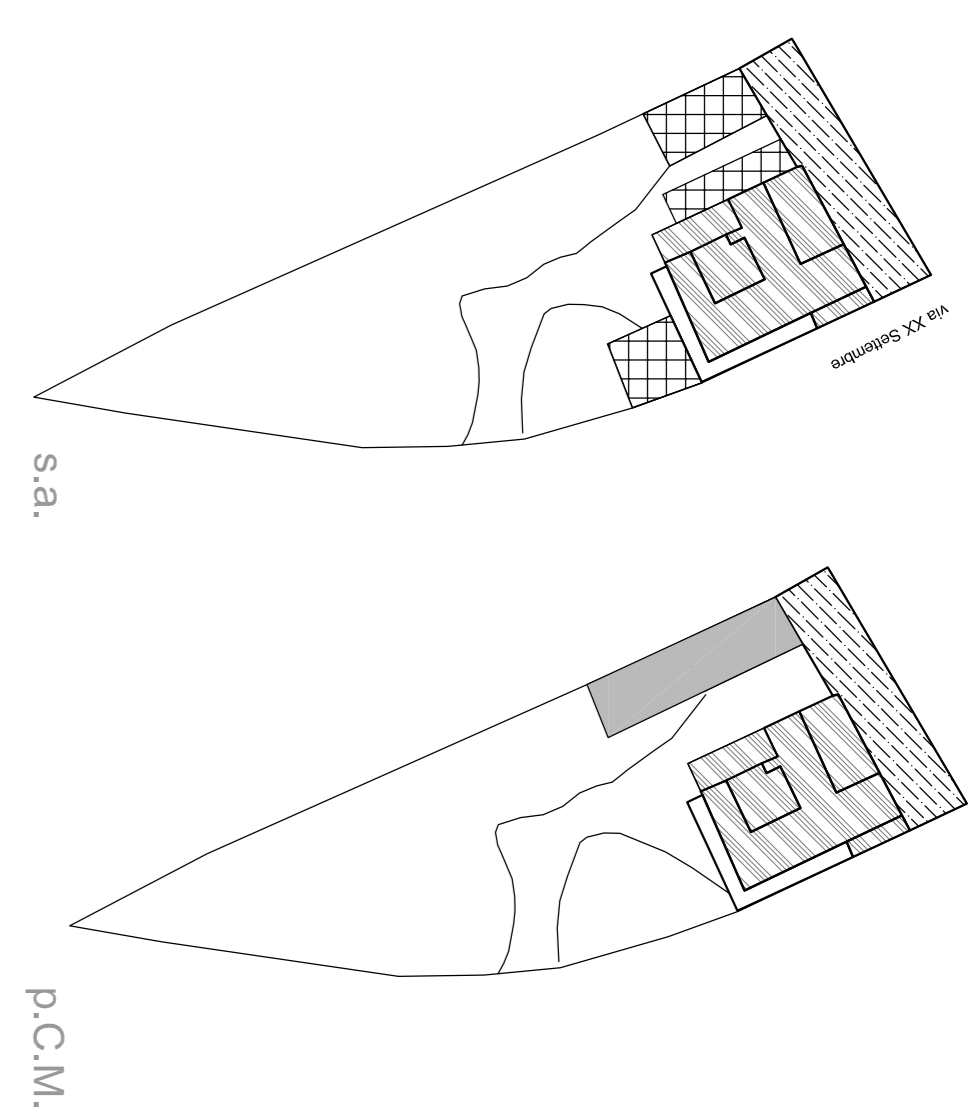

ISOLATO E - U.E. 1

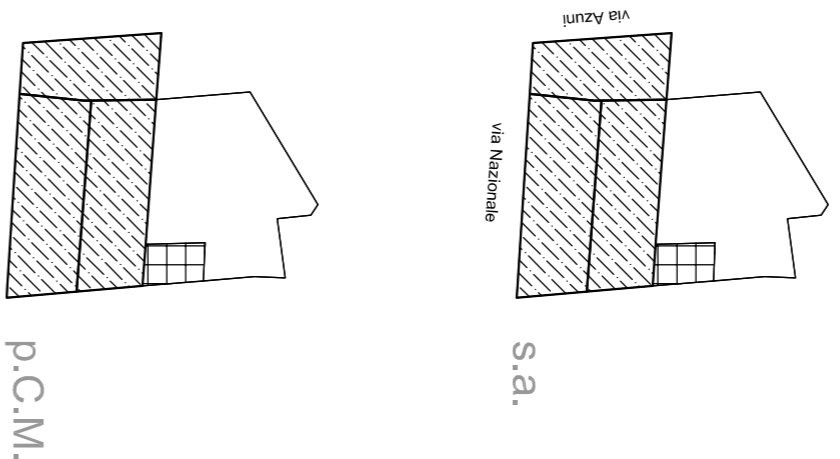

ISOLATO E - U.E. 2

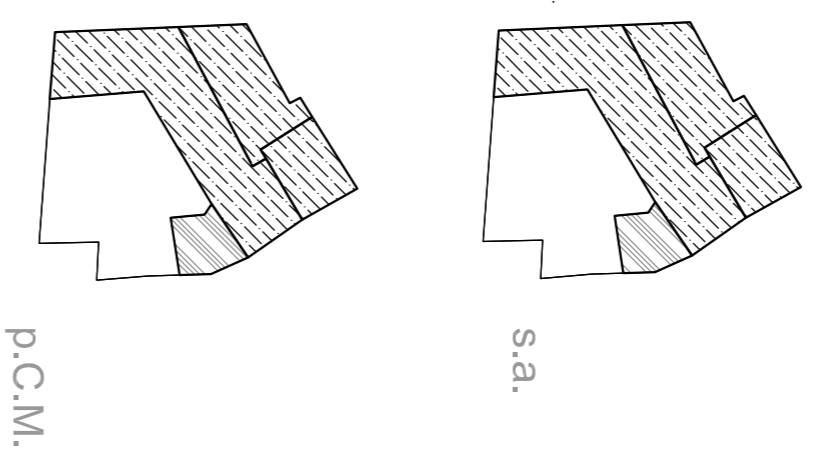

ISOLATO E - U.E. 3

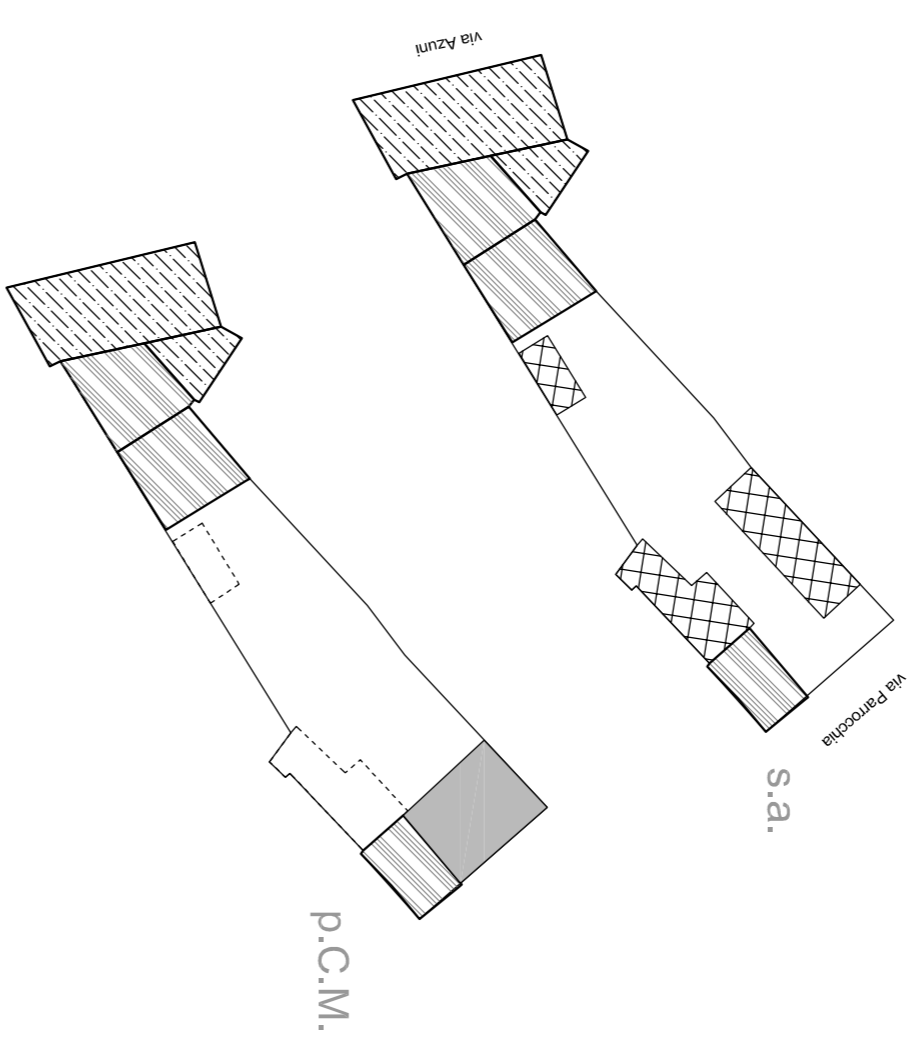

ISOLATO E - U.E. 4

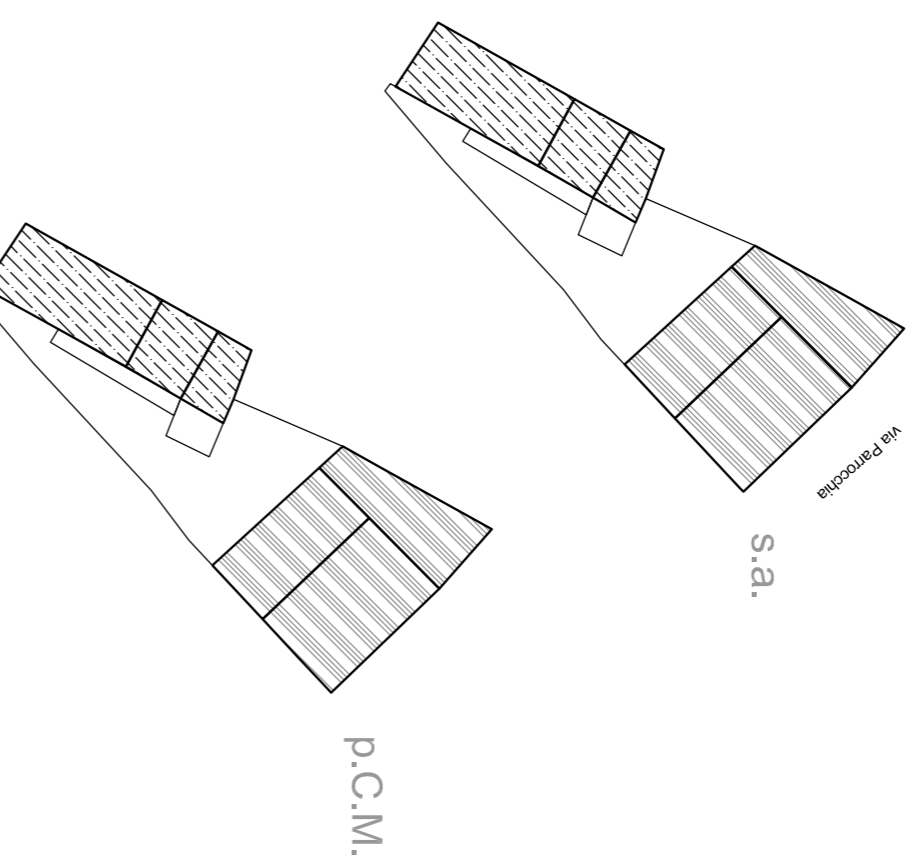

ISOLATO E - U.E. 5

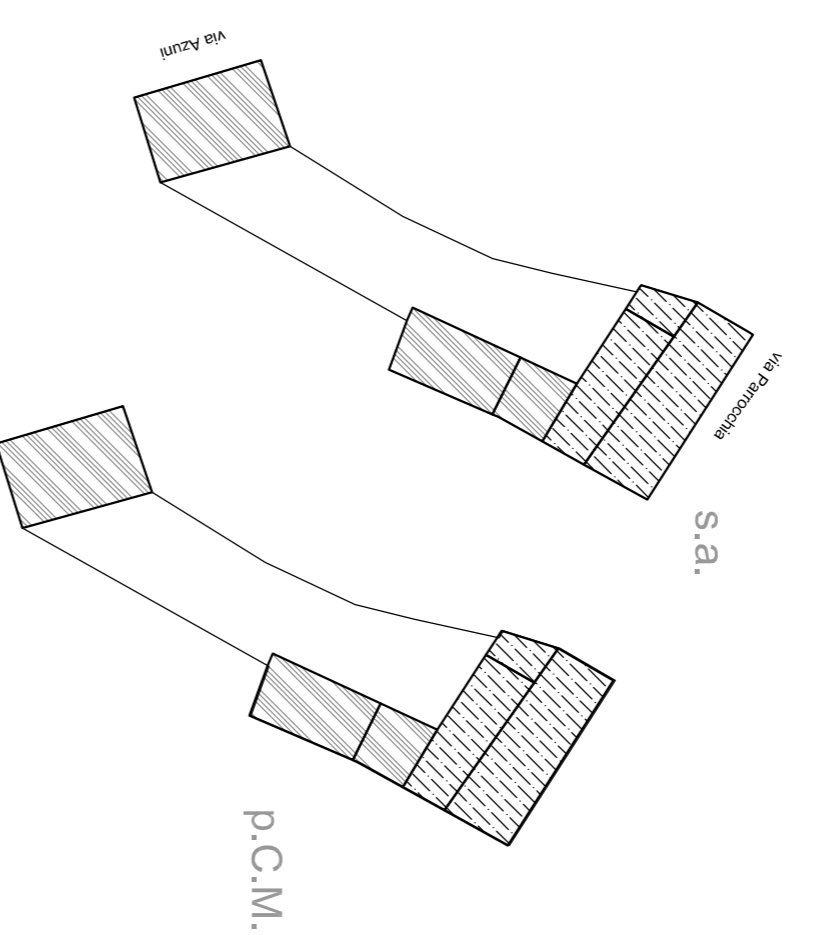

ISOLATO E - U.E. 6

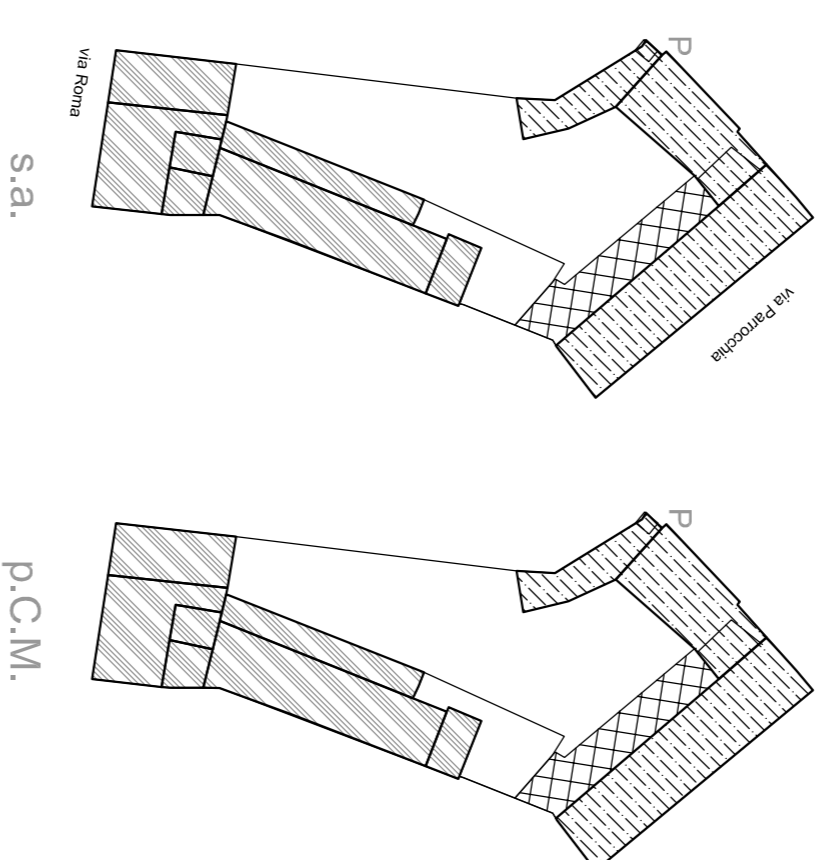

ISOLATO E - U.E. 7

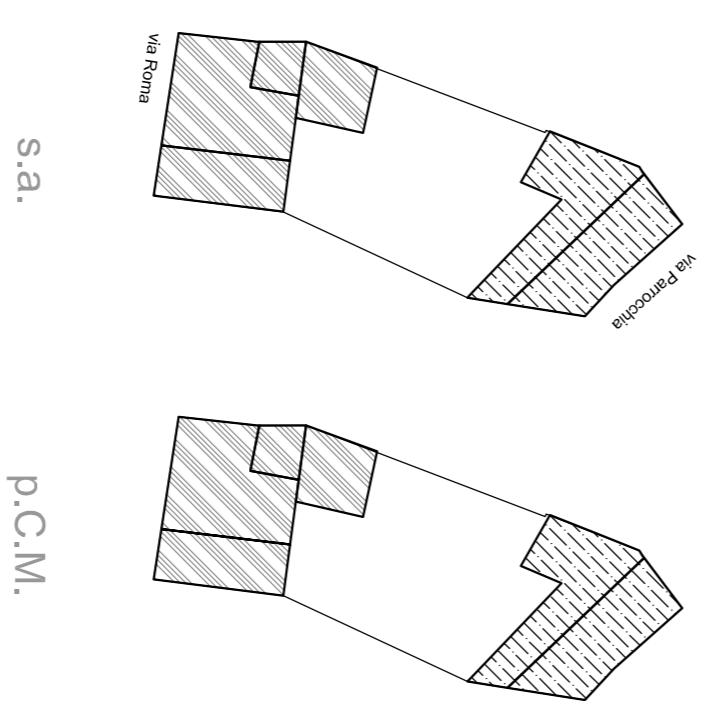

ISOLATO F - U.E. 1

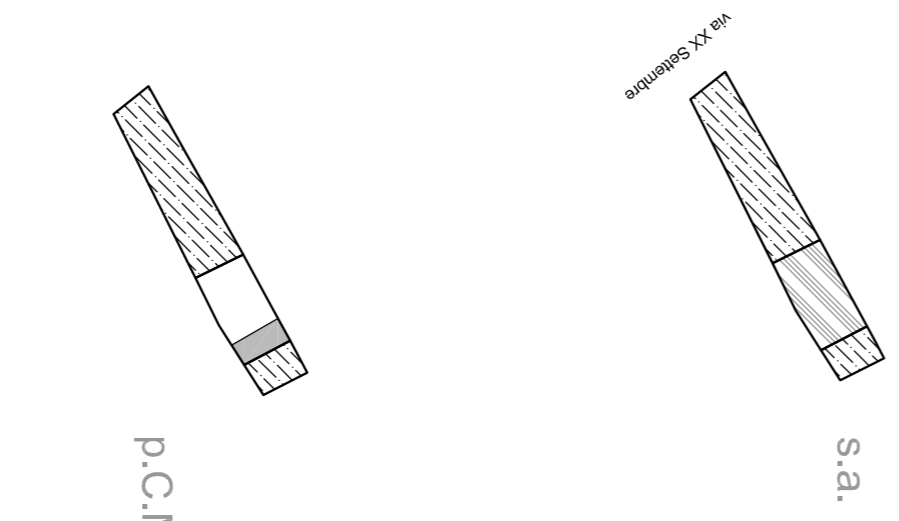

ISOLATO F - U.E. 2

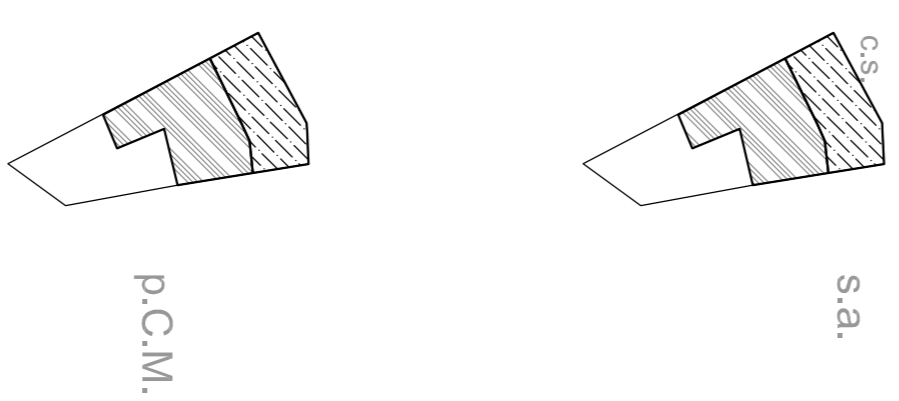

ISOLATO F - U.E. 3

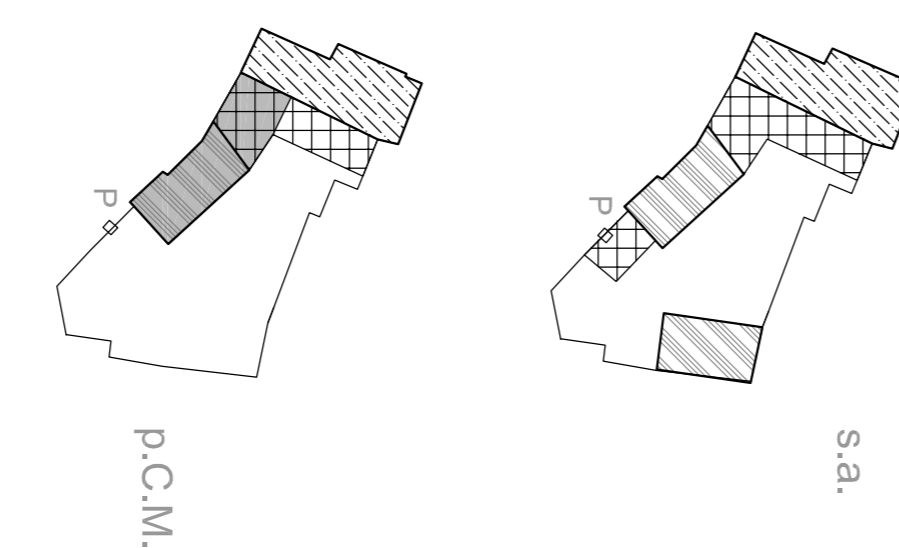

ISOLATO F - U.E. 4

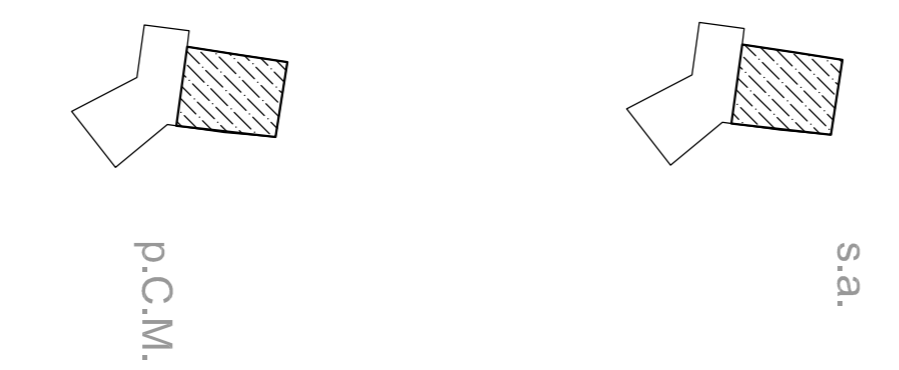

ISOLATO F - U.E. 5

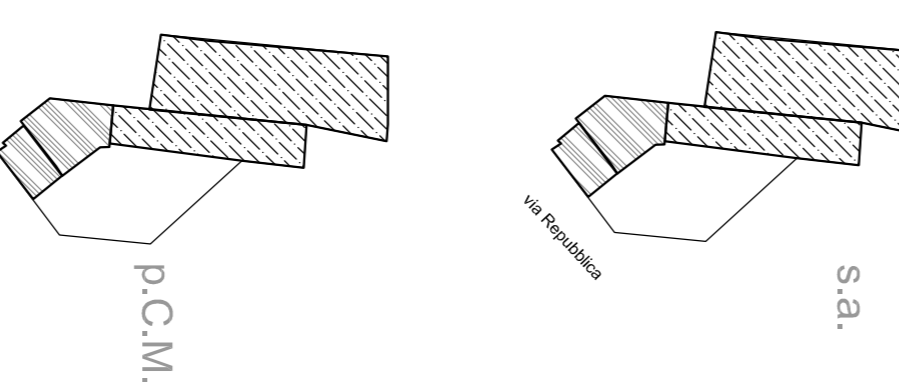

ISOLATO F - U.E. 6

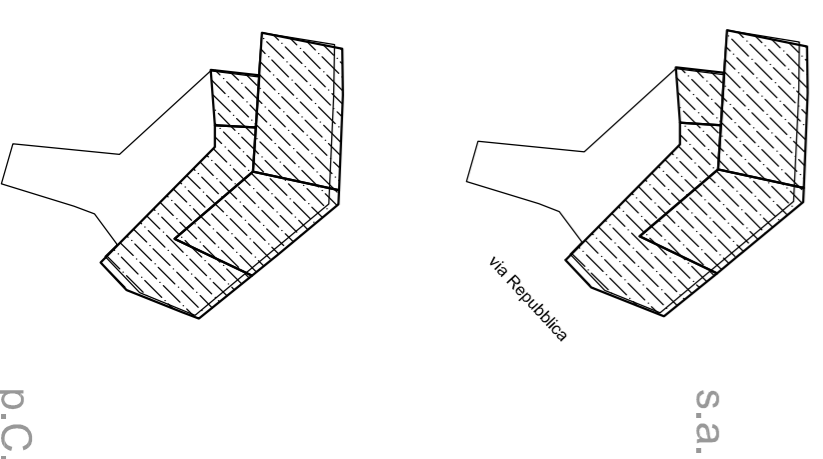

ISOLATO F - U.E. 7

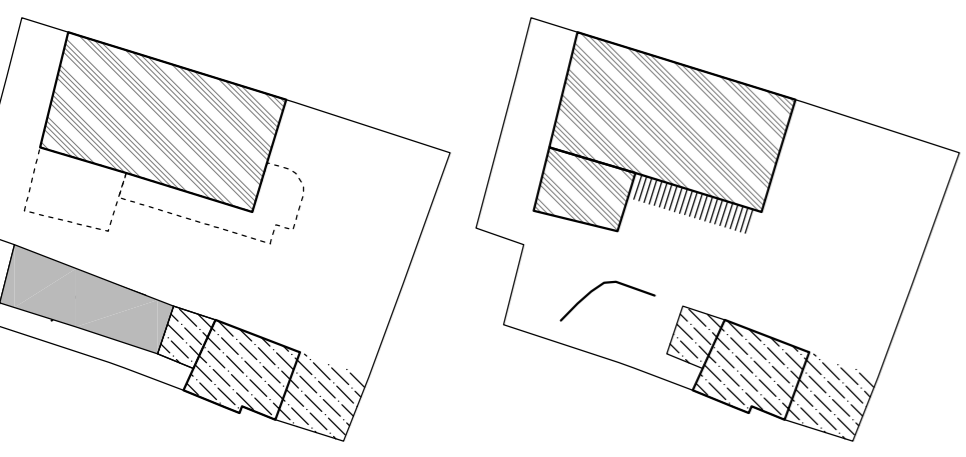

ISOLATO F - U.E. 8

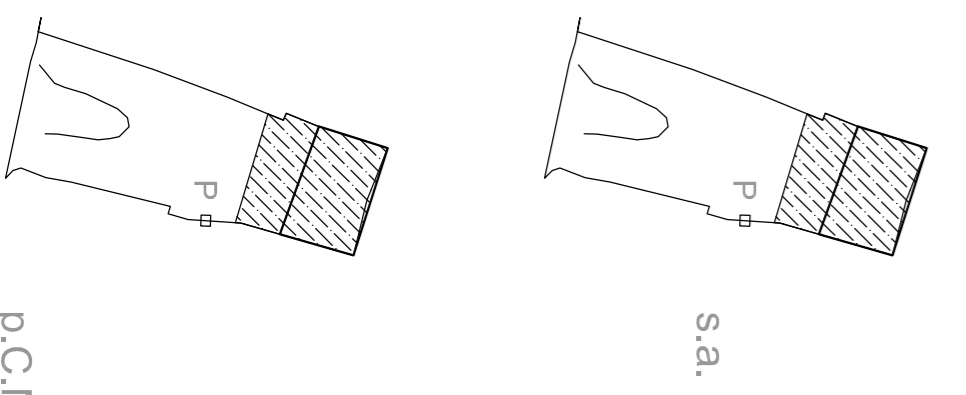

ISOLATO F - U.E. 9

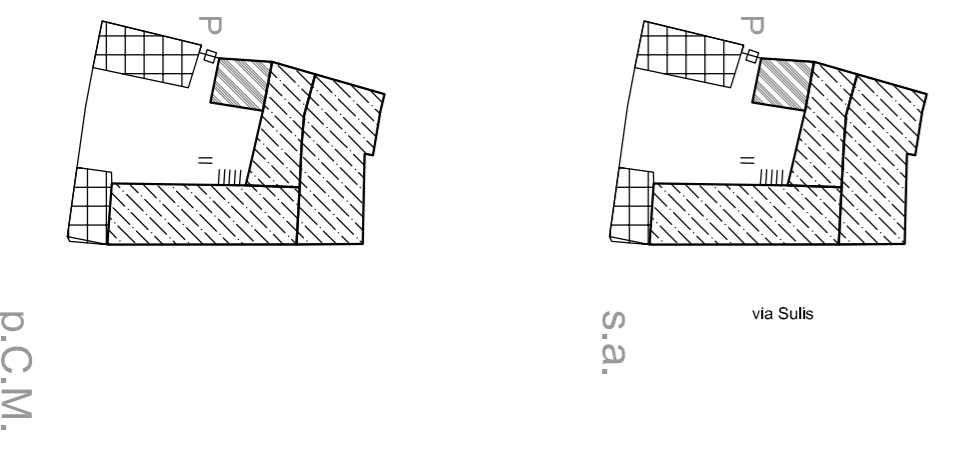

- S.a. Stato attuale
- p.c.m. Prescrizioni del Piano Particolareggiato del Centro Matrice
- demolizioni
- caseggiato storico con possibile ampliamento al piano superiore
- caseggiato storico
- caseggiato di nuova costruzione
- pozzo da salvaguardare
- canale di scolo acque
- possibile ampliamento

# COMUNE DI VILLAPUTZU PROVINCIA DI CAGLIARI

## PIANO PARTICOLAREGGIATO DEL CENTRO MATRICE DI VILLAPUTZU

in adeguamento alle osservazioni dell'ufficio del servizio di tutela paesaggistica della R.A.S. (prot. 27541 del 05/08/2010)

### PROGETTO DEFINITIVO

OGGETTO: POSSIBILI INTERVENTI SUGLI EDIFICI STORICI ILEVATI

Coordinatore: Ing. GINEVRA BALLETTO  
Progettisti: Ing. ALBACIARA BERGAMINI, Ing. FRANCESCO LECIS COCCO-ORTU

Collaboratori: Ing. ALESSANDRA SCALAS

Comune di Villaputzu: Ing. Silvia Ianni

Fonte: **10a**

Archivio: L. 125  
Data: settembre 2011  
Approvazione: 2013  
Scade: aprile 2014